

NO EXCUSES!



XL8

Graphic Annunciator

The XL8 Graphic Annunciator is the information station. This unit displays a pictorial description, such as building layout, to provide an accurate location of an alarm. The application of the XL8 ranges from fire alarm to "Nurse Call" stations, as well as door alarms, security, process monitoring and control.

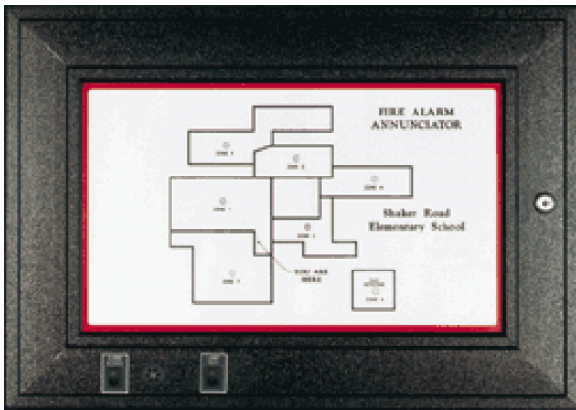

Illumination Styles:

Standard Features:

- Choice of LED or incandescent backlit illumination for zone or point identification
- Choice of seven standard cabinet sizes (A, B, C, D, F, H and J)
- Indoor (BL) or outdoor (WA) enclosures
- 1/8" Lexan® window
- Flush (flange available) or surface mounting
- Piano hinge with CAT 30 keyed door lock
- Red or black textured enclosure finishes
- 02, 12 or 24VDC operating voltages
- Positive or negative zone input
- Interface with panel driver board's electronics for Annunciator operation
- Hard wire circuits available
- Driver boards installed by SAE

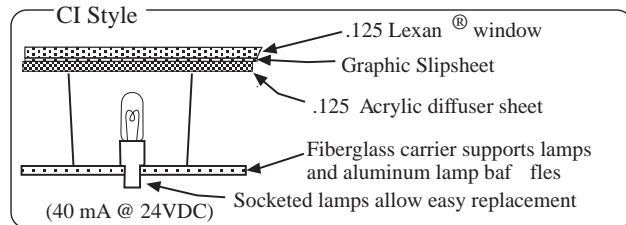
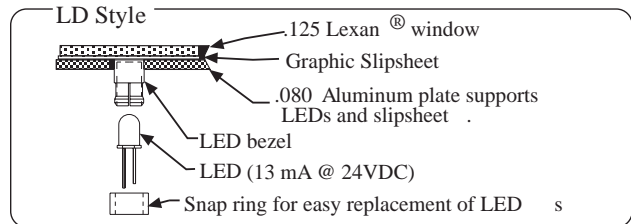

ISO 9001 REGISTERED COMPANY

PANELVu

Space Age Electronics, Inc.
www.Isae.com
800.486.1723 Toll Free
508.485.0966 Local
508.485.4740 Fax

Specifications:

The XL8 Graphic Annunciator is available in a wide range of sizes to meet your graphic's size requirements. Multiple illumination styles aid in clearly conveying your graphic information. Choice of high intensity LED's (available in a multitude of colors), socketed backlit lamps or a combination of both.

The XL8 Graphic Annunciator consists of a Lexan® face panel and an extruded aluminum cover frame with a choice of several standard back boxes proportionally sized and constructed of extruded aluminum with flush or surface mount options. A solid stainless steel piano hinge and a high security CAT 30 keyed door lock accompany the door for secure, easy access to the graphics and electronics. Choice of LED or incandescent backlit illumination for zone or point identification specific to the customer supplied graphics and requirements. Zone input either positive or negative in 12, 24 or 2VDC operating voltages. The unit also interfaces with panel driver boards for basic annunciator operation. A variety of hardwired electronic circuits are offered by SAE. Wiring cable(s) lead to a 2-point slide connector at the terminal input board.

The display incorporates LED point illumination or incandescent backlit zones behind the graphic faceplate with pluggable, high intensity LED's or incandescent bulbs, thus allowing simple field replacement. The LED's mount into clear bezels and are secured with a snap rings. Incandescent bulbs are a socketed type and are easily replaceable.

Size	Overall Unit Size	Usable Graphic Area
A	23 1/2" x 13"	16 1/2" x 6"
B	23 1/2" x 16 1/2"	16 1/2" x 9 1/2"
C	23 1/2" x 20"	16 1/2" x 13"
D	23 1/2" x 23 1/2"	16 1/2" x 16 1/2"
F	23 1/2" x 30 1/2"	16 1/2" x 23 1/2"
H	23 1/2" x 37 1/2"	16 1/2" x 30 1/2"
J	23 1/2" x 44 1/2"	16 1/2" x 37 1/2"

Note: Cutout for flush mounting subtract 1" from overall unit size.

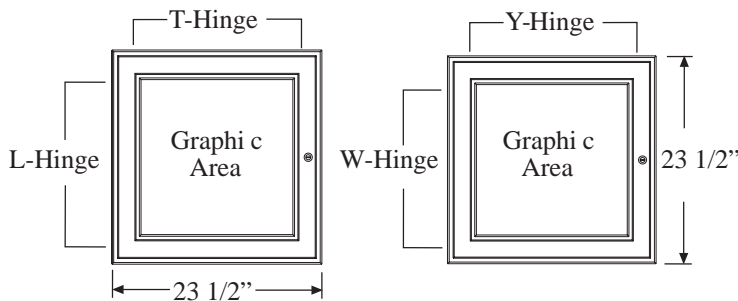

Mounting

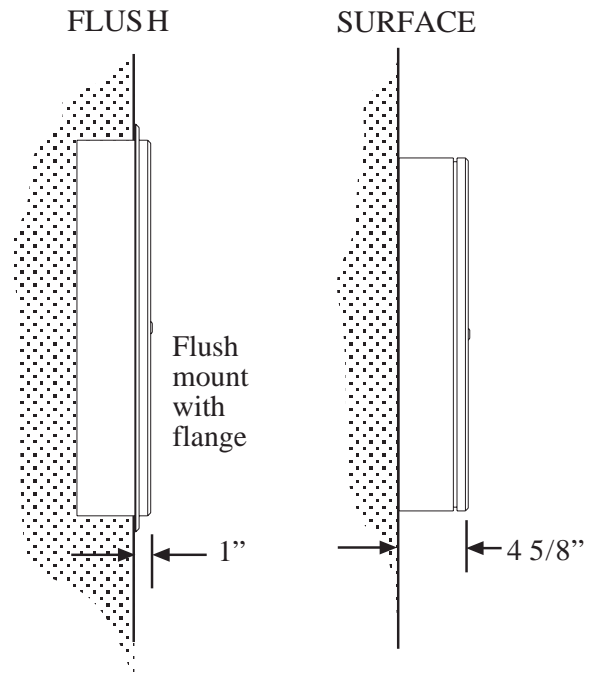

PANELVU

Space Age Electronics, Inc.
 www.1sae.com
 800.486.1723 Toll Free
 508.485.0966 Local
 508.485.4740 Fax

Agency Listings:

UL	UOXX.S2580	Control Unit Accessories
MEA	355-91-E	
CSFM	7120-0553:102	

This document is subject to change without notice, see doc # ED0479 for legal disclaimer

Ordering Information:

Follow the 10 steps and fill in this XL8 Graphic Annunciator

Order Code or try our free on-line Product Quote Pages at www.1SAE.com

XL8 - - - - - - - - D - 1

① ① ② ③ ④ ⑤ ⑥ ⑥ ⑦ ⑦ ⑧ ⑧ ⑧ ⑨ ⑩

① Indoor / Outdoor

CODE	DESCRIPTION
BL	Indoor enclosure
WA	Outdoor enclosure

② Hinge Type

CODE	DESCRIPTION
L	Hinged on left side of cover and 23 1/2" horizontal.
T	Hinged on top and 23 1/2" horizontal.
W	Hinged on left and 23 1/2" vertical.
Y	Hinged on top and 23 1/2" vertical.

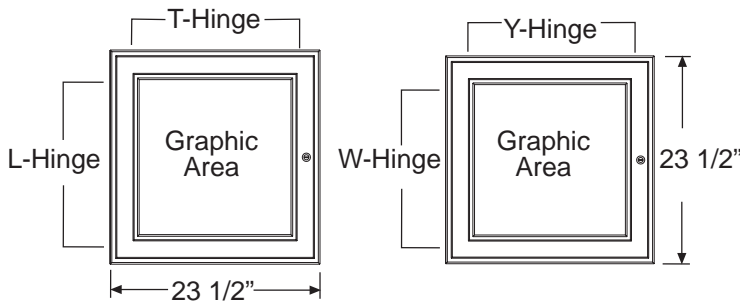

③ Size

CODE	Overall Unit	Usable Graphic Area
A	23 1/2" x 13"	16 1/2" x 6"
B	23 1/2" x 16 1/2"	16 1/2" x 9 1/2"
C	23 1/2" x 20"	16 1/2" x 13"
D	23 1/2" x 23 1/2"	16 1/2" x 16 1/2"
F	23 1/2" x 30 1/2"	16 1/2" x 23 1/2"
H	23 1/2" x 37 1/2"	16 1/2" x 30 1/2"
J	23 1/2" x 44 1/2"	16 1/2" x 37 1/2"

④ Mounting

CODE	DESCRIPTION
S	Surface
F	Flush

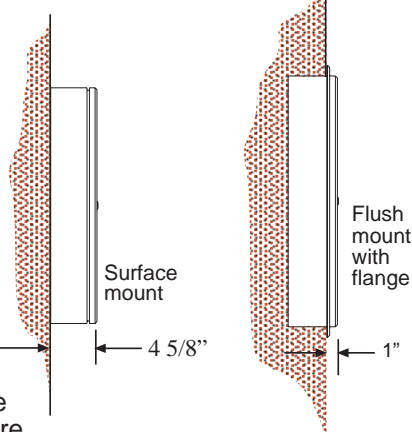

⑤ Color

CODE	DESCRIPTION
R	Red enclosure
B	Black enclosure
Z	Custom finish

Notes

- 1: Standard graphic display is white background with black linework.
- 2: Standard LED's are red and incandescent lamps are clear.

⑥ Graphic Illumination

CODE	DESCRIPTION
LD	LED Point Lit
MD	LED Point Lit
CI	Incandescent backlight

See page 1 for illumination style clarification

⑦ Voltage

CODE	DESCRIPTION
02	2 Volts
12	12 Volts
24	24 Volts

⑧ Wiring options

CODE	DESCRIPTION
SLO	Standard wiring
SLT	Lamp test
SHM	Audible with silence and LED
SHT	SLT + SHM Combined
SHR	Trouble audible w/ silence and LED
SDA	Switch labeled "ALARM SILENCE" and "RESET", with audible alarm
SCC	Common form 'C' output
SHH	Audible wired to high barrier terminal strip
CSE	Customer supplied equipment

DRV - Fire Panel point "LED" driver board

- Select Type:
- 01 Simplex/Grinnell
 - 02 Siemens / Cerberus
 - 03 Notifier
 - 04 Firelite
 - 05 Silent Knight
 - 06 FCI
 - 07 Secutron
 - 08 Harrington
 - 09 Gamewell
 - 10 Fike
 - 11 Edwards (EST)
 - 12 Faraday
 - 13 Kidde Fire Systems
 - 14 Other: _____

See Circuit Description Sheet LT10140 for Details

⑨ Wiring Option Switch Type

CODE	DESCRIPTION
K	Key switch
O	Rocker switch
X	No switch

⑩ Zone Input

CODE	DESCRIPTION
1	Negative zone input
3	Positive zone input

Name: _____
 Company: _____
 Phone #: _____
 e-mail: _____

Include your contact information and fax to Space Age for a quote.

PANELVU

Space Age Electronics, Inc.
www.1sae.com
800.486.1723 Toll Free
 508.485.0966 Local
 508.485.4740 Fax

Circuit Description:

- UL SLO** (EL0001) For normally open field contacts (blocking diode provided) requiring an individual input per zone. When an alarm condition exists, the corresponding zone's LED/lamp illuminates. Normalization of the field contact extinguishes the zone's LED/lamp.
- UL SLT** (EL0004) For normally open field contacts (blocking diode provided) requiring an individual input per zone. When an alarm condition exists, the corresponding zone's LED/lamp illuminates. A key or rocker switch labeled "Lamp Test" ** lights all LEDs/lamps simultaneously. Normalization of the field contact extinguishes the zone's LED/lamp.
- UL SHM** (EL0017) For normally open field contacts (blocking diode provided) requiring an individual input per zone. When an alarm condition exists, the corresponding zone's LED/lamp illuminates, common form 'C' output energizes, 'trouble' LED and horn activate. A maintaining key or rocker switch labeled "Alarm Silence" silences the horn. Normalization of the field contact extinguishes the zone's LED/lamp, 'trouble' LED, deactivates the Form 'C' output and rings back the horn to remind the operator to return the switch to its' normal position.
- UL SHT** (EL0018) (Combination of SLT and SHM) For normally open field contacts (blocking diode provided) requiring an individual input per zone. When an alarm condition exists, the corresponding zone's LED/lamp illuminates, common form 'C' output energizes, 'trouble' LED and horn activate. A maintaining key or rocker switch labeled "Alarm Silence" silences the horn. Normalization of the field contact extinguishes the zone's LED/lamp, 'trouble' LED, deactivates the Form 'C' output and rings back the horn to remind the operator to return the switch to its' normal position. A key or rocker switch labeled "Lamp Test" ** lights all LEDs/lamps simultaneously.
- UL †SHR** (EL0005) For normally open field contact (blocking diode provided). Upon a input to the 'T' terminal, the common Form 'C' output energizes, 'trouble' LED and horn activate. A maintaining key or rocker switch labeled "Trouble Silence" silences the horn. Normalization of the field contact extinguishes the 'trouble' LED, deactivates the Form 'C' output and rings back the horn to remind the operator to return the switch to its' normal position.
- UL †RTI** (EL0021) For normally open field contact (isolated 2 VDC input, no blocking diode provided). Upon activation of the RTI card, the common Form 'C' output energizes, 'trouble' LED and horn activate. A maintaining key or rocker switch labeled "Trouble Silence" silences the horn. Normalization of the field contact extinguishes the 'trouble' LED, deactivates the Form 'C' output and rings back the horn to remind the operator to return the switch to its' normal position.